

NLO 514

NY 126 - 5

AEP-71

2.23.26

AMERICAN MACHINE & FOUNDRY COMPANY  
OCCUPATIONAL EXPOSURE TO RADIOACTIVE DUST

BY

Paul B. Klein  
Industrial Hygiene Branch  
Health & Safety Division

Issued: February 18, 1952

Distributions:

- 1 - File
- 2 - American Machine & Foundry Co.
- 3 - Belmore, Production
- 4 - Belmore, Production
- 5 - Permald Area
- 6 - File

U. S. Atomic Energy Commission  
New York Operations Office  
Health & Safety Division

## TABLE OF CONTENTS

	<u>Page</u>
Scope	1
Purpose	1
Summary of Results	1,2
Method of Study	2
Job Analysis Sheets	3
Discussion	3,4
A-G Automatic Six Spindle Lathe	4
Duration of Exposure	5
Conclusion	5,6
Table I - Average Daily Weighted Exposures	
Figure I - Alpha Dust Exposure over an 10 Hour Day	
Drawing I - Exhaust System	
Drawing 2 - Acme-Gridley Six Spindle Lathe	
Drawing 3 - Centerless Grinder	
Drawing 4 - Warner and Swasey Lathe	

### APPENDIX A

Job Analysis Sheets

### APPENDIX B

Sample Record Sheets

### APPENDIX C

List of Personnel

### APPENDIX D

Floor Plan- Radiation Monitoring

## SCOPE

This is the report of a survey conducted by P. B. Klovin and M. S. Weinstein at the American Machine and Foundry Company during the period of October thru January 1952. The survey covered the health and safety problems existing during the machining of uranium on an Acme Gridley six spindle automatic lathe, a Warner Swazy single spindle lathe and a Centerless Grinder. Recommendations are included in this report for ventilation and other health and safety improvements.

## PURPOSE

This survey was made with the following objectives in mind:

1. To gather data from which an estimation of the daily weighted average exposure can be determined for personnel working on the A.E.C. project;
2. To provide a basis for recommending additional control designs and procedures;
3. To provide data for the dust exposure history of personnel;
4. To assist in the specification of controls for future similar installations.

## SUMMARY OF RESULTS

Number of personnel studies.....	7
Average exposure ( $d/m^3$ ).....	250
Maximum exposure ( $d/m^3$ ).....	1625
Less than 70 $d/m^3$ .....	71.6%
70 to 210 $d/m^3$ .....	14.2%
over 210 $d/m^3$ .....	14.2%

$d/m^3$  - disintegrations per minute per cubic meter of air.  
70  $d/m^3$  - maximum allowable concentration (M.A.C.)

The centerless grinding operation was the only operation of the three studied at which significantly high dust exposure was found. A daily weighted exposure of 1625  $d/m^3$  was found for the operator at the receiving end of the grinder.

Although the Acme-Gridley lathe operator was exposed to an average breathing zone concentration of 177  $d/m^3$  while operating the six spindle automatic lathe, his average daily weighted exposure was only 97  $d/m^3$  (1.4) M.A.C.

The remaining five personnel studied were exposed to acceptable dust concentrations.

Recommendations are included which should reduce existing airborne contamination at centerless grinder and Acme-Gridley automatic lathe operation.

#### METHOD OF STUDY

Dust samples were collected on 11/8" Whatman #41 filter paper using a 0.5 cfm universal air sampler. All samples were counted for uranium alphas on a alpha scintillation counter.

An operational, time and work study of the uranium machining activities in the Radar Shed was rather difficult since operations, although on a semi-production schedule, were frequently interrupted by tool breakage, tool adjustment, fires, and other time consuming delays. It was therefore necessary to supplement our observed operational time study with additional figures supplied by Mr. Charles Pellicani, supervisor of A.E.C. project for American Machine and Foundry Company.

The operations involved in the machining of uranium pieces are shown for the following units:

1. Stop
2. Hollow milling
3. Facing
4. Hollow milling
5. Hollow milling
6. Pickup, cut off (Facing)

This unit is normally operated at 800 rpm, (about 200 surface feet) having one spindle and one speed feed. The normal feasible rate of production is 300 pieces per hour.

I. Single Spindle Warner Swazy #3 turret lathe performs the following tool operations:

1. Facing
2. Cut-off

The lathe is normally operated at approximately 300 surface feet per minute. The normal rate of production is 80-100 pieces per 10 hours.

II. Centerless Grinder is used to remove the last .009" from slug. The grinder is normally operated at 1100 RPM.

## JOB ANALYSIS SHEETS

The job analysis sheets give a detailed analysis of the operational time relationship of each employee on the project. This consists of a statement of the total time spent on a particular job with an additional breakdown as to the number of minutes each task is performed per shift. In addition, the average alpha concentration as obtained from the sample record sheets is recorded. The average alpha concentration multiplied by the total time is depicted in the last column. The average concentration per 10 hour day is determined by dividing alpha concentration times total time by the total number of minutes per shift. Finally, the multiple of the preferred level (M.A.C.) is determined by dividing the daily average concentration.

## DISCUSSION

Table 1 and Figure 1 summarize the average daily weighted personnel exposures over a 10 hour day.

The results of this survey show the centerless grinder operation to be responsible for the highest individual personnel exposure found for any project employee.

A daily weighted concentration of  $1625 \text{ d/m}^3$  was found for the operator at the receiving end of the grinder. An average breathing zone concentration of  $13,000 \text{ d/m}^3$  obtained during the actual grinding operation performed for only 75 minutes represents the sole dust exposure of the operator. The inadequacy of the ventilation control at this unit is responsible for fumes and mists observed during the centerless grinding operation.

The Acme-Gridley Six Spindle Automatic Lathe initially was the first machine in the project area and this survey was actually made to gain information as to its safe performance. In early October this office was asked to make a survey of the automatic lathe operation. Initially, a lubricant coolant, Gulf Lard Sulphur Base Cutting Oil A plus 10% Gulf Mineral Seal Oil was employed. After several flash fires occurred during the single spindle operation using the oil coolant, the coolant flow of 45 gal/min of the machine was increased with a booster to 115 gal/min.

Six breathing zone general air samples taken with all the six spindles in operation revealed an average concentration of  $<1 \text{ d/m}^3$ . Flash fires still persisted and it was decided that machining with the Gulf Oil coolant was too hazardous. A water soluble coolant was then utilized.

No flash fires were observed after this change was made. Breathing zone - general air samples were again taken at the A-G automatic lathes. The following table compares dust concentrations found during full air spindle operation with ventilation exhaust inoperative and operative:

A-G AUTOMATIC BE SPINDLE LATHE

Location	Condition	Concentration (d/m <sup>3</sup> )			No. of Samples
		Average	High	Low	
East Side A-G	Ventilation "Off"	210	500	130	2
East Side A-G	Ventilation "On"	221	640	26	6
West Side A-G	Ventilation "Off"	120	130	110	2
West Side A-G	Ventilation "On"	194	470	62	6

The above table effectively shows the ineffectiveness of the present canopy type hood over the A-G lathes.

Ventilation control at the Warner Swazy #3 turret lathe was found to be adequate. Five BF samples taken during operation of the single spindle lathe with no ventilation revealed an average concentration of 1750 d/m<sup>3</sup>, highest of three being 2000 and lowest, 1400. After applying ventilation, the effects were quite evident. An average of <1 d/m<sup>3</sup> was found for 5 BF samples taken with ventilation "On".

In addition to the dust survey, an area radiation survey and personnel finger badge study was conducted in the project area. Figure II shows the result of the area survey made using a Juno instrument. Housekeeping was good. Most instrument readings ranged from 0-2,000 αd/m/100cm<sup>2</sup>. Several measurements of 3-5000 αd/m/100cm<sup>2</sup> were found directly in front of the centerless grinder and Warner Swazy lathe. These were due to fine uranium shavings that were not entrapped by the solvent, etc. The highest readings 50-100,000 αd/m/100cm<sup>2</sup> were measured at the scrap pans under the automatic shaving remover of the A-G lathes. It was suggested to American Machine and Foundry supervisory personnel that the scrap contents be removed from the pans frequently and that the scrap shavings be immersed in oil. The finger badges study made during inspection of 100 pieces of uranium metal follows:

DURATION OF EXPOSURE - 4 HOURS

<u>Right Hand</u>	<u>mrep B</u>	<u>Left Hand</u>	<u>mrep B</u>
Thumb	100	Thumb	80
Index	160	Index	130
Middle	80	Middle	100
Ring	130	Ring	80
Small	200	Small	110

From the above table, the highest exposure was found for the small finger of the right hand. Based on a weekly exposure (6 days) the individual inspector, upon whose fingers the films were placed was exposed to 3000 mrep/wk. This value exceeds the maximum permissible dose by a factor two. (See Recommendation).

CONCLUSION

In order to reduce airborne contamination at the machine sites and external radiation to employees on the project, the following recommendations are presented:

1. Acme-Gridley Automatic Lathe

Rec. #1- Install sheet metal curtains to present canopy hood. Form fit to contour of lathe to provide for maximum exhaust through any required open area.

2. Centerless Grinder

Rec. #2- Alter existing hood for centerless grinder to incorporate additional enclosure features to provide for a maximum exhaust velocity through any required open area. Use plexiglass curtains wherever direct viewing of work is necessary.

Rec. #3- A slide and chute should be provided at the discharge side of the grinder to receive slugs from the grinder. This will eliminate need for the receiving operators close proximity to the grinder.

3. Warner Swasey Single Spindle Lathe

Rec. #4- Install a flexible duct to the exhaust hood at the lathe to allow for greater maneuverability and flexibility of the present hood. The above recommendations have been discussed with Mr. Battine of American Machine & Foundry Co. and Mr. G. Dunlap of Production Division.

4. External Radiation Protection

Rec. #5. Provide Inspectors and piece stamper with leather palmed, cotton backed gloves.

Rec. #6. Provide machinists with an oil and water impervious type protective gloves.

5. General

Rec. #7. Necessary fire precautions for handling uranium scrap should be taken i.e.:

1. Uranium shavings should be removed to drum storage frequently.

2. Uranium shavings should be stored in drums with shavings fully covered by oil.

Rec. #8. Areas surrounding the lathes and grinder should be frequently cleaned up to prevent any spread of contamination.



TABLE I

AVERAGE DAILY WEIGHTED EXPOSURES

<u>Job</u>	<u>Number of Personnel</u>	<u>Concentration (c/m<sup>3</sup>)</u>
Project Supervisor	1	0
Acme-Gridley Lathe Operator	1	97
Warner-Swary Lathe Operator	1	33
C-O Receiving Operator	1	1625
Slug Stamper	1	0
Inspector	2	0
Total Personnel	<u>7</u>	
Overall Average Exposure		250

WEIGHTED AVERAGE EXPOSURE (WAE)

Occupation	0	1.0	2.0	3.0	4.0
AMERICAN MACHINE AND TOOL CO. AEC Project Area ALPHA DUST EXPOSURE OVER AN 10 HR DAY					
Project Supervisor			1		
Acme-Bridley Lathe Operator			1		
Warner-Swazy Lathe Operator			1		
Centerless Grinder Operator					21.2
Slur Stomper			1		
Inspector			2		
Overall Average Exposure					7

Notes: Number above bar represents total personnel at specified occupation.

Figure I

UNITED STATES ATOMIC ENERGY COMMISSION  
 NEW YORK OPERATIONS  
 HEALTH AND SAFETY DIVISION  
 70 COLUMBUS AVE. NEW YORK 23, N.Y.  
 DRAWN BY \_\_\_\_\_  
 APPROVED BY \_\_\_\_\_  
 AMERICAN MACHINE & FOUNDRY CO.  
 EXHAUST SYSTEM, A.C. MACHINES  
 SCALE 1/8" = 1'-0" | DWG. NO. 1 | DATE \_\_\_\_\_

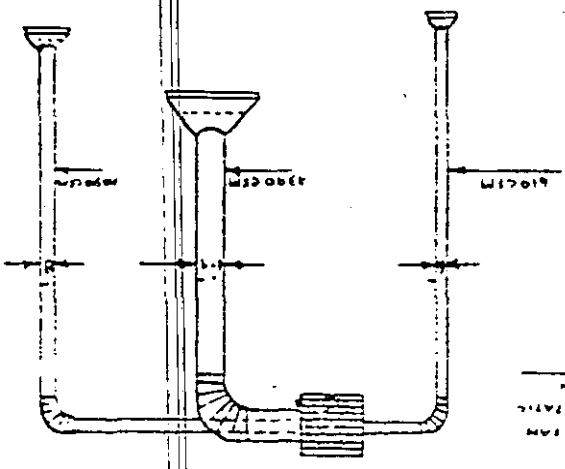

STANDARD ELECTRIC LEAD FOR  
 USE WITH MOTOR, INSTEAD OF STATIC  
 COLLECTOR AS SHOWN IN FIG. 208

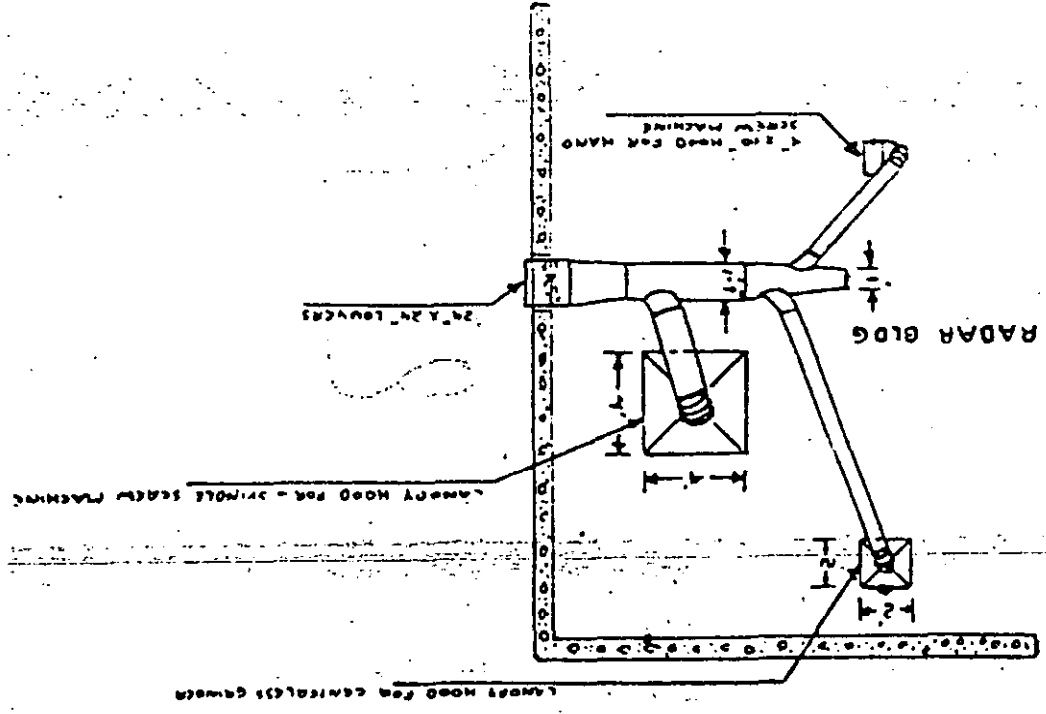
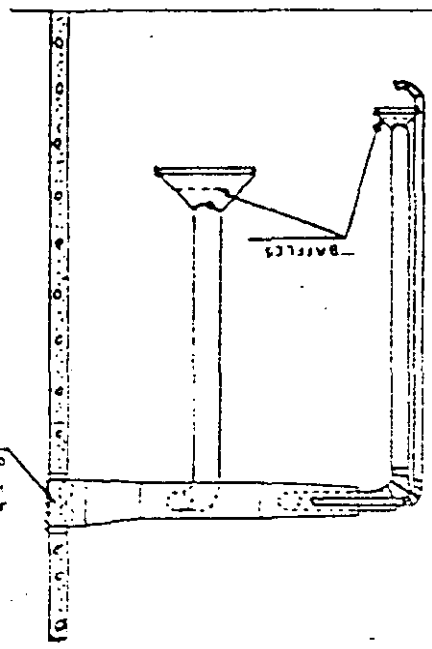

LAMP HOOD FOR CONTROLS (SEE DRAWING)

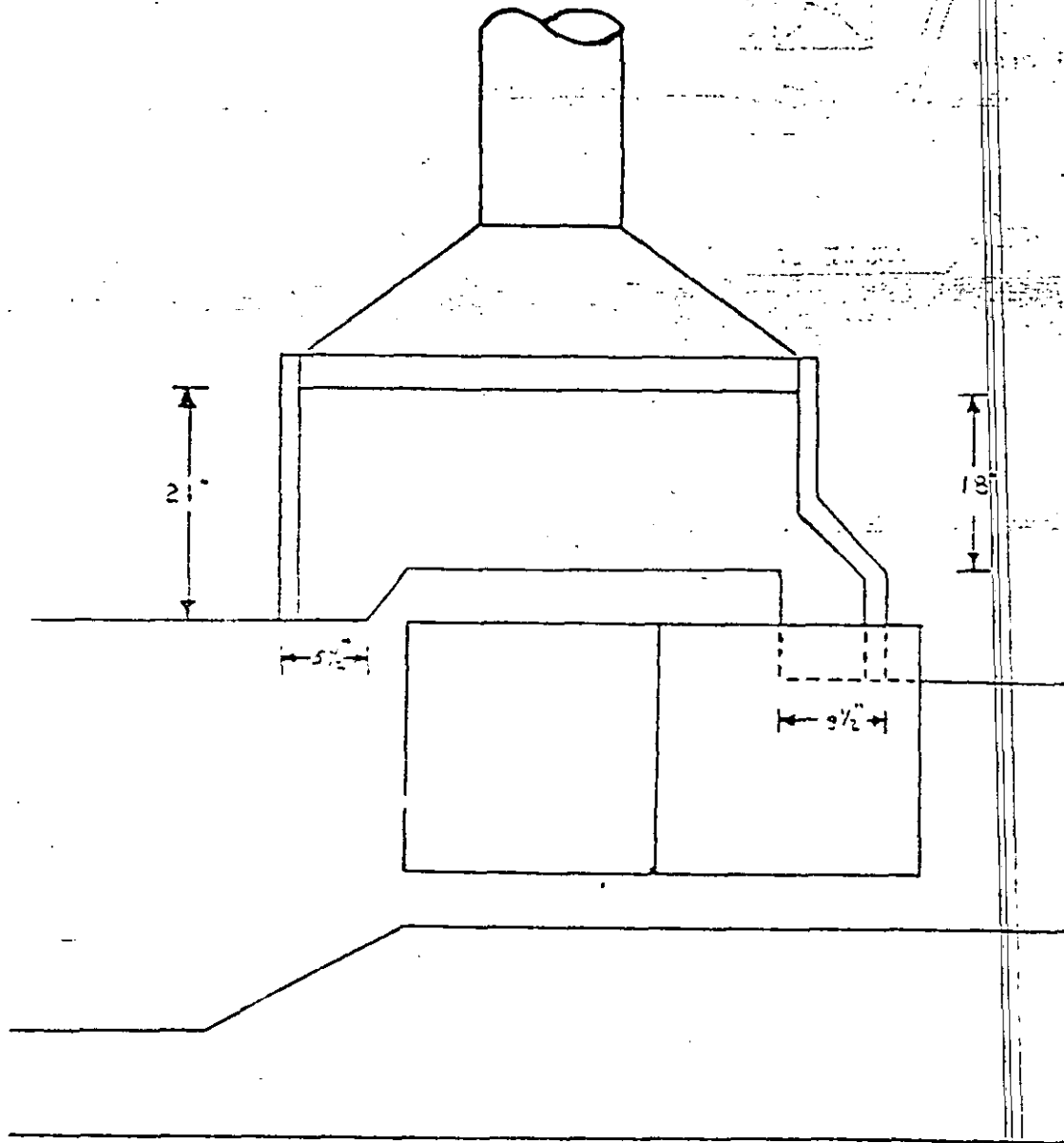

UNITED STATES ATOMIC ENERGY COMMISSION  
 NEW YORK OPERATIONS  
 HEALTH AND SAFETY DIVISION  
 70 COLUMBUS AVE. NEW YORK 23, N.Y.

DRAWN BY	APPROVED BY
AMERICAN MACHINE AND TOOL WORKS ACME-GRIDLEY SIX SPINDLE LATHE	

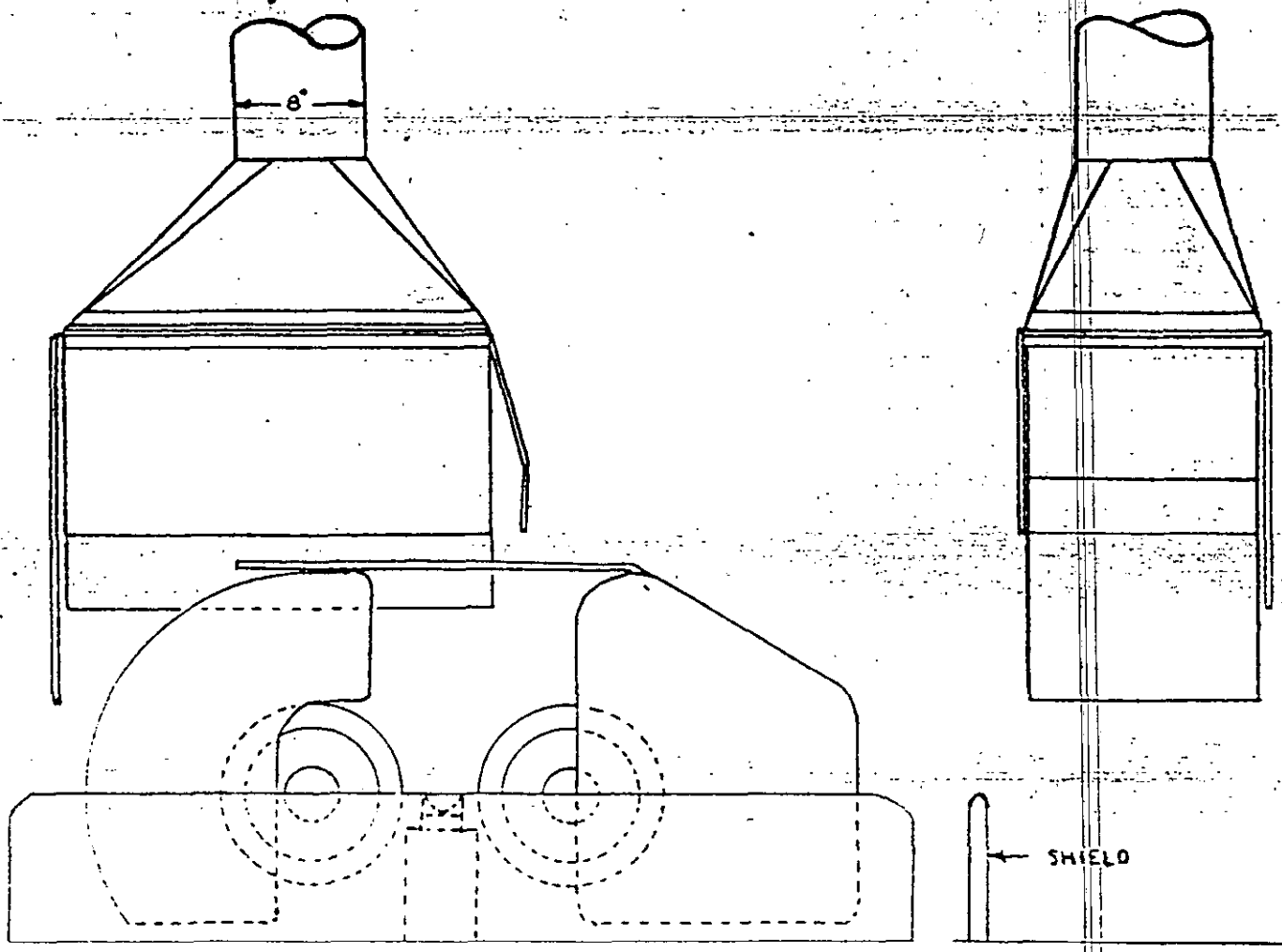

PRESENT SET-UP

UNITED STATES ATOMIC ENERGY COMMISSION NEW YORK OPERATIONS HEALTH AND SAFETY DIVISION 70 COLUMBUS AVE., NEW YORK 23, N.Y.		
DRAWN BY AMERICAN MACHINE AND FOUNDRY	APPROVED BY CENTERLESS GRINDER	
SCALE	DWG. NO. 3	DATE

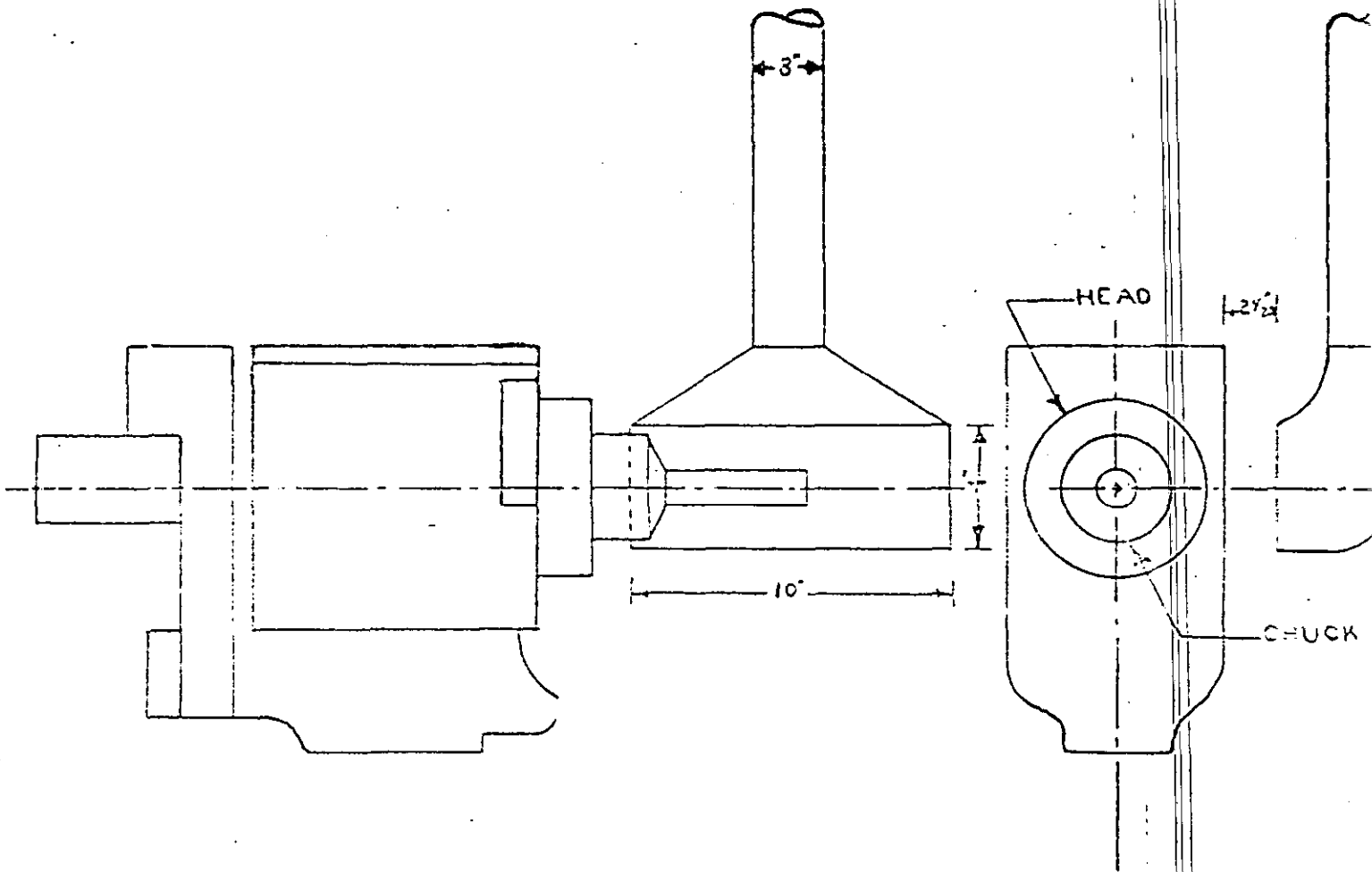

PRESENT SET-UP

UNITED STATES ATOMIC ENERGY COMMISSION  
 NEW YORK OPERATIONS  
 HEALTH AND SAFETY DIVISION  
 70 COLUMBUS AVE., NEW YORK 23, N.Y.

DRAWN BY	APPROVED BY
AMERICAN MACHINE AND FOUNDRY	WARNER AND SWASEY LATHE

SCALE	DWG. NO. 4	DATE
-------	------------	------

OPERATOR: \_\_\_\_\_ 2 men/shift; 1 shifts/day; 2 men/day

Operation or Operating Area	Time Per Opera. (min)	Opera. Per Shift	Time Per Shift (min)(T)	No. of Samp- les	Concentration d/s/m <sup>3</sup>			Avg Con'c Times Total Tim- (T X C)
					Low	High	(3) Avg	
G. A. ABC Project Area	-	-	600	11	<1	<1	<1	-

\* Adjusted to two significant figures.

$\Sigma T = 60$

$\Sigma(T \times C) = -$

$$\Sigma \frac{(T \times C)}{\Sigma(T)} = \frac{0}{60} = 0 \quad \frac{d/s/m^3}{\text{m}^3} = 0$$

Times the Maximum Allowable Concentration

LIST OF PERSONNEL ON U.S.A.M.C. PROJECT

American Machine & Foundry Company

<u>Name</u>	<u>Job</u>
Charles Pellicari	Supervisor
Sy Dutohak	A-G Lathe Operator
Joseph D'Angalis	Operator, Warner-Swasey Lathe
Theodore Buckley	Receiver Operator Centerless Grinder
Herbert Mackey	Inspector
Carl Flygt	Piece Stumper
Louis Crealdi	Inspector



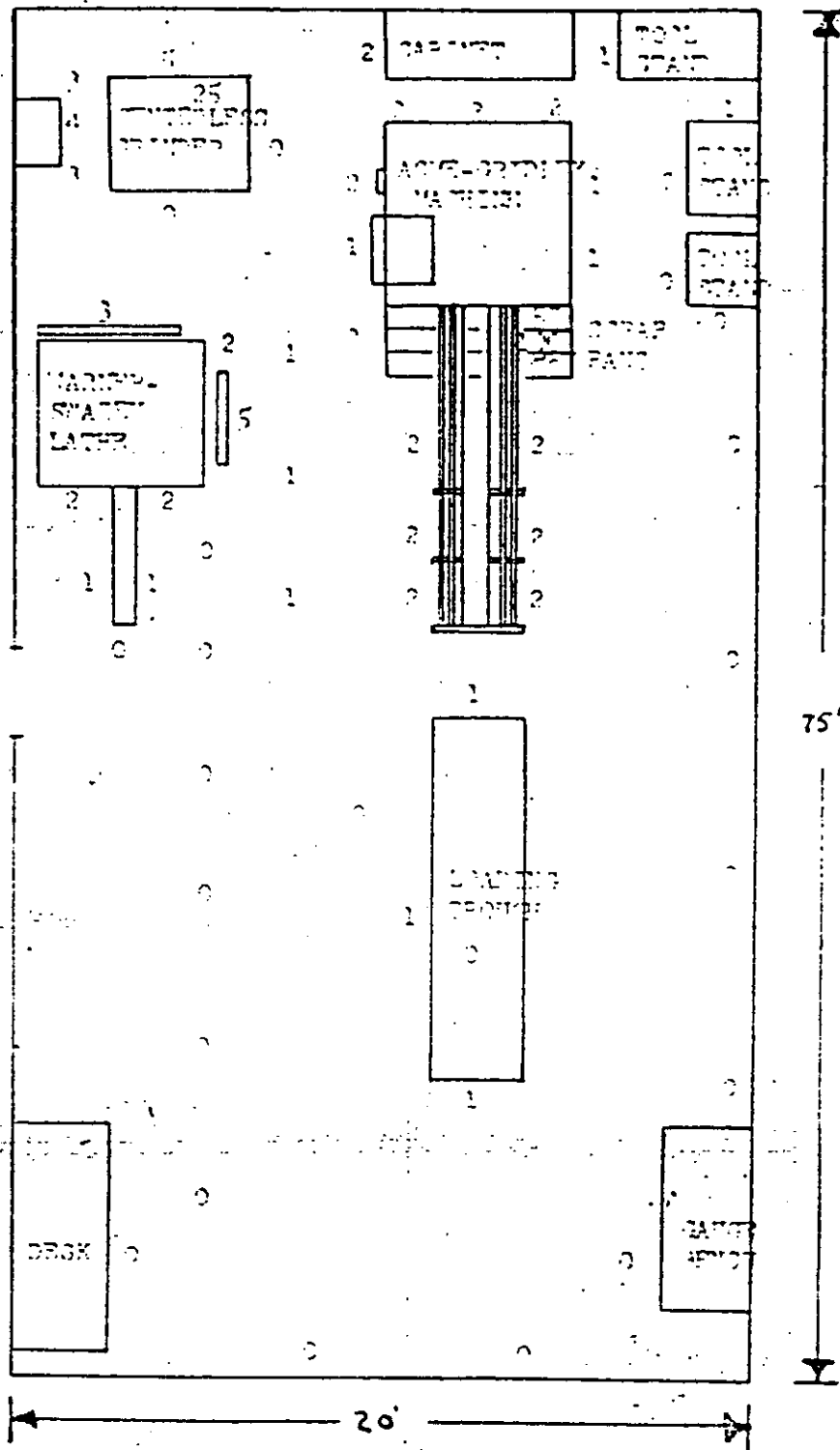

NOTE: JUNG INSTRUMENT USED  
IN SURVEY

ALL NUMBERS SHOULD BE  
MULTIPLIED BY 1000 TO  
EXPRESS ALPHA CONT-  
AMINATION IN  $d/m/100cm^2$

UNITED STATES ATOMIC ENERGY COMMISSION

NEW YORK OPERATIONS

HEALTH AND SAFETY DIVISION

70 COLUMBUS AVE., NEW YORK 23, N.Y.

DRAWN BY

APPROVED BY

AMERICAN MACHINE AND FOUNDRY  
RADIATION MONITORING

SCALE

DWG. NO. Fig. 2

DATE

OPERATOR: STEVE STRUBER

3 men/shift; 1 shifts/day; 1 men/day

Operation or Operating Area	Time Per Opera. (min)	Opera. Per Shift	Time Per Shift (min)(T)	No. of Samp- les	Concentration d/m <sup>3</sup>			Avg Con'c. Times Total Time (T X C)
					Low	High	(C) Avg	
Stamping 10 pieces	2	3	80	2	<1	<1	<1	-
O.A. for project Area	-	-	520	11	<1	<1	<1	-

\* Adjusted to two significant figures.

$\Sigma T$  600

$\Sigma (T \times C)$  0

$\Sigma \frac{(T \times C)}{\Sigma T} = \frac{0}{600} \text{ d/m}^3 = 0$

Times the Maximum Allowable Concentration.